

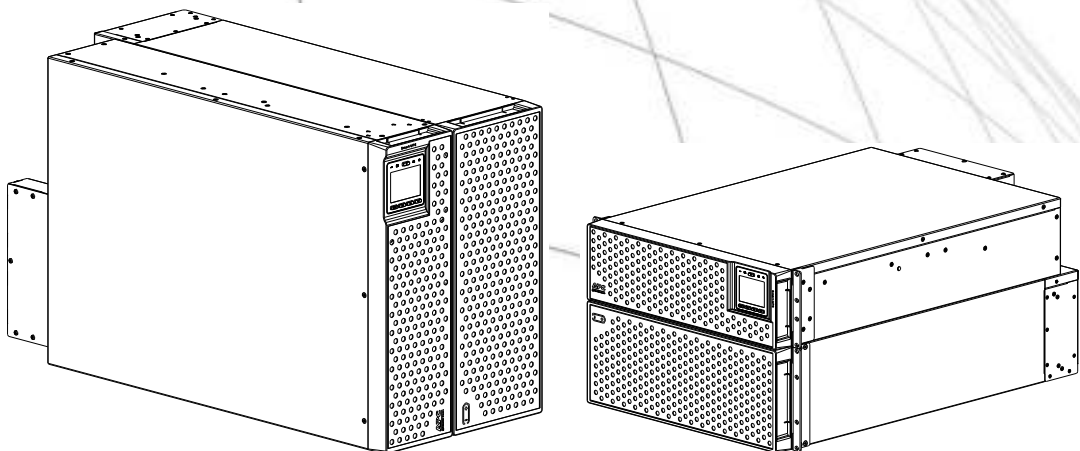

# Operation Manual

## Smart-UPS™ RT Uninterruptible Power Supply

SRTG15KXLI  
SRTG20KXLI  
Tower/Rack-Mount





# Important Safety Instructions

Read the instructions carefully and look at the equipment to become familiar with the device before trying to install, operate, service or maintain it. The following special messages may appear throughout this document or on the equipment to warn of potential hazards or to call attention to information that clarifies or simplifies a procedure.



The addition of this symbol to either a “Danger” or “Warning” safety label indicates that an electrical hazard exists which will result in personal injury if the instructions are not followed.



This is the safety alert symbol. It is used to alert you to potential personal injury hazards. Obey all safety messages that follow this symbol to avoid possible injury or death.

## **DANGER**

**DANGER** indicates a hazardous situation which, if not avoided, **will result in** death or serious injury.

## **WARNING**

**WARNING** indicates a hazardous situation which, if not avoided, **could result in** death or serious injury.

## **CAUTION**

**CAUTION** indicates a hazardous situation which, if not avoided, **could result in** minor or moderate injury.

## **NOTICE**

**NOTICE** is used to address practices not related to physical injury.

# Product Handling Guidelines



# Safety and General Information

**Inspect the package contents upon receipt. Notify the carrier and dealer if there is any damage.**

- Changes and modifications to this unit not expressly approved by APC by Schneider Electric could void the warranty.
- This unit is intended only for indoor use in a controlled environment.
- Do not operate this unit in direct sunlight, in contact with fluids, or where there is excessive dust or humidity.
- Be sure the air vents on this unit are not blocked. Allow adequate space for proper ventilation.
- For a UPS with a factory installed power cord, connect the UPS power cable directly to a wall outlet. Do not use surge protectors or extension cords.
- The battery typically lasts for two to five years. Environmental factors impact battery life. Elevated ambient temperatures, poor quality utility power, causing frequent short duration discharges will shorten battery life.
- Up to 4 external battery packs (XLBP) can be connected to the UPS in parallel. The number of external battery packs connected can be set using the LCD display.

**Note: For each XLBP added, increased recharge time will be required.**

- The equipment is heavy. Always practice safe lifting techniques adequate for the weight of the equipment.
- The batteries are heavy. Remove the batteries before installing the UPS and external battery packs (XLBPs), in a rack.
- Always install XLBPs at the bottom in rack-mount configurations. The UPS must be installed above the XLBPs.
- Always install peripheral equipment above the UPS in rack-mount configurations.
- Additional safety information can be found in the Safety Guide supplied with this unit.
- Battery breaker must be turned off when the UPS is not operating for a long time.

## Deenergizing safety

The UPS contains internal batteries and may present a shock hazard even when disconnected from the branch circuit (mains). The AC output connectors may be energized by remote or automatic control at any time. Before installing or servicing the equipment check that the:

- Input wall circuit breaker is in the OFF position.
- Internal UPS batteries are removed.
- XLBP battery modules are disconnected.

## Electrical safety

- For models with a hardwired input, the connection to the branch circuit (mains) must be performed by a qualified electrician.
- 230 V models only: In order to maintain compliance with the EMC directive for products sold in Europe, output cords attached to the UPS must not exceed 10 meters in length.
- The protective earth conductor for the UPS carries the leakage current from the load devices (computer equipment). An insulated ground conductor is to be installed as part of the branch circuit that supplies the input power to the UPS. The conductor must have the same size and insulation material as the grounded and ungrounded branch circuit supply conductors. The conductor will typically be green and with or without a yellow stripe.
- The UPS input ground conductor must be properly bonded to protective earth at the service panel.
- If the UPS input power is supplied by a separately derived system, the ground conductor must be properly bonded at the supply transformer or motor generator set.

## Battery safety

### CAUTION

#### **RISK OF HYDROGEN SULPHIDE GAS AND EXCESSIVE SMOKE**

- Replace the battery at least every 5 years or at the end of its service life, whichever is earlier.
- Replace the battery immediately when the UPS indicates battery replacement is necessary.
- Replace batteries with the same number and type of batteries as originally installed in the equipment.
- Replace the battery immediately when the UPS indicates a battery over-temperature condition, or when there is evidence of electrolyte leakage. Power off the UPS, unplug it from the AC input, and disconnect the batteries. Do not operate the UPS until the batteries have been replaced.
- \*Replace all battery modules (including the modules in External Battery Packs) which are older than one year, when installing additional battery packs or replacing the battery module(s).

**Failure to follow these instructions can result in minor or moderate injury and equipment damage.**

\* Contact APC by Schneider Electric Customer Support to determine the age of the installed battery modules.

- Before replacing batteries, remove conductive jewelry such as chains, wrist watches, and rings. High energy through conductive materials could cause severe burns.
- Do not dispose of battery or batteries in a fire. The batteries may explode.
- Do not open or mutilate batteries. Released electrolyte is harmful to the skin and eyes, and may be toxic.
- Servicing of user replaceable batteries should to be performed or supervised by personnel knowledgeable about batteries and required precautions.
- A battery can present a risk of electric shock and burns by high short-circuit current.
- Failed batteries can reach temperatures that exceed the burn thresholds for touchable surfaces.

## Hardwire safety

- Verify that all branch circuit (mains) and low voltage (control) circuits are deenergized, and locked out before installing cables or making connections, whether in the junction box or to the UPS.
- Wiring by a qualified electrician is required.
- Check national and local codes before wiring.
- Strain relief is required for all hardwiring (not supplied). Snap in type strain reliefs are recommended.
- All openings that allow access to UPS hardwire terminals must be covered. Failure to do so may result in personal injury or equipment damage.
- Select wire size and connectors according to national and local codes.

## General information

- The model and serial numbers are located on a small, rear panel label.
- Always recycle used batteries.
- Recycle the package materials or save them for reuse.

## Radio frequency warning

This UPS is a category C3 product as per IEC 62040-2, meant for commercial and industrial application in the second environment installation restrictions or additional measures may be needed to prevent disturbances.

# Product Description

The Smart-UPS™ On-Line SRTG is a high performance uninterruptible power supply (UPS). The UPS helps provide protection for electronic equipment from utility power blackouts, brownouts, sags, surges, small utility power fluctuations and large disturbances. The UPS also provides battery backup power for connected equipment until utility power returns to normal levels or the batteries are completely discharged. This user manual is available on the APC by Schneider Electric Web site, [www.apc.com](http://www.apc.com).

## Specifications

For additional specifications refer to the APC by Schneider Electric Web site, [www.apc.com](http://www.apc.com).

### Environmental

|  |                  |   |
|--|------------------|---|
| <b>Temperature</b>   | <b>Operating</b> | 0 to 40 °C (32 to 104 °F)   |
|  | <b>Storage</b>   | -15 to 45 °C (5 to 113 °F)  |
| <b>Maximum Elevation</b>   | <b>Operating</b> | 0 - 3,000 m (0 - 10,000 ft)<br>0 - 1,000 m no derating;<br>1,000 to 3,000 m,<br>power reduction of 1%/100 m |
|  | <b>Storage</b>   | 0 to 15,000 m (0 to 50,000 ft)  |
| <b>Humidity</b>  |                  | 0% to 95% relative humidity, non-condensing   |
| <b>International Protection Code</b>   |                  | IP20  |
| <p><b>Note:</b> Charge the battery modules every six months during storage.<br/>Environmental factors impact battery life. Elevated ambient temperatures, high humidity, poor quality mains power, causing frequent short duration discharges will shorten battery life.</p> |                  |   |

### Physical

The UPS is heavy. Follow all lifting guidelines.

|  |   |
|--|---|
|  | SRTG15KXLI / SRTG20KXLI                     |
| <b>Unit weight without packaging</b>   | 142.5 kg                                    |
| <b>Unit weight with packaging</b>  | 157.2 kg                                    |
| <b>Unit dimensions without packaging Height x Width x Depth</b>              | 306 x 440 x 700 mm (12.0 x 17.3 x 27.6 in.) |
| <b>Unit dimensions with packaging Height x Width x Depth</b>                 | 535 x 590 x 790 mm (21.1 x 23.2 x 31.1 in.) |
| The model and serial numbers are on a small label located on the rear panel. |   |

## Battery

|  |   |
|--|---|
| <b>UPS model</b>   | SRTG15KXLI / SRTG20KXLI                             |
| <b>XLBP model</b>  | SRTG192XLBP2  |
| <b>Replacement battery module</b><br>This UPS has replaceable battery modules.<br>Refer to the appropriate replacement battery user manual for installation instructions.<br>Contact your dealer or go to the APC by Schneider Electric Web site, <a href="http://www.apc.com">www.apc.com</a> , for information on replacement batteries. | APCRBC172   |
| <b>Battery voltage</b><br><b>Ah rating</b>   | ±192 VDC<br>9 Ah                                    |
| <b>Battery type</b>  | Sealed Maintenance Free Valve Regulated Lead Acid   |
| <b>Max. number of battery pack</b>   | 4 battery packs excluding the one supplied with UPS |
| <b>XLBP cable length</b>   | 0.64 m  |

|                             |   |
|-----------------------------|---|
| <b>UPS model</b>            | SRTG15KXLI / SRTG20KXLI                     |
| <b>Number of batteries</b>  | 1 - 5 (including the one supplied with UPS) |
| <b>Ah rating</b>            | 9 Ah  |
| <b>charger current*</b>     | 1.8 - 5 A                                   |
| <b>Max. charger current</b> | 5 A   |

\* refers to  $I_{\text{charge}} = 0.2 \times (\text{AH for each battery pack}) \times (\text{No. of battery packs})$

| UPS                      | XLBP         | RBC       | Parallel Kit | Rail Kit   |
|--------------------------|--------------|-----------|--------------|--|
| SRTG15KXLI<br>SRTG20KXLI | SRTG192XLBP2 | APCRBC172 | SRTGPK01     | SRTGRK1 for UPS Power Module<br>SRTGRK2 for Battery Pack |

## Electrical

| Models     | Rating         |
|------------|----------------|
| SRTG15KXLI | 15 kVA / 15 kW |
| SRTG20KXLI | 20 kVA / 20 kW |

### Output

|                        |   |
|------------------------|---|
| Output Frequency       | 50/60 Hz ± 4 Hz   |
| Nominal Output Voltage | Phase to neutral : 220/230/240 VAC (*1:1 & *3:1 )<br>Phase to phase : 380/400/415 VAC (*3:3 ) |

### Input

|                       |   |
|-----------------------|---|
| Input Frequency       | 38 to 72 Hz   |
| Nominal Input Voltage | Phase to neutral : 220/230/240 VAC (1:1)<br>Phase to phase : 380/400/415 VAC (3:1 & 3:3 ) |

\*1:1: 1 phase input / 1 phase output

\*3:1: 3 phase input / 1 phase output

\*3:3: 3 phase input / 3 phase output

Hereinafter referred to as “1:1”, “3:1” and “3:3” respectively.

# Product Overview

- 1 Front bezel
- 2 LCD module

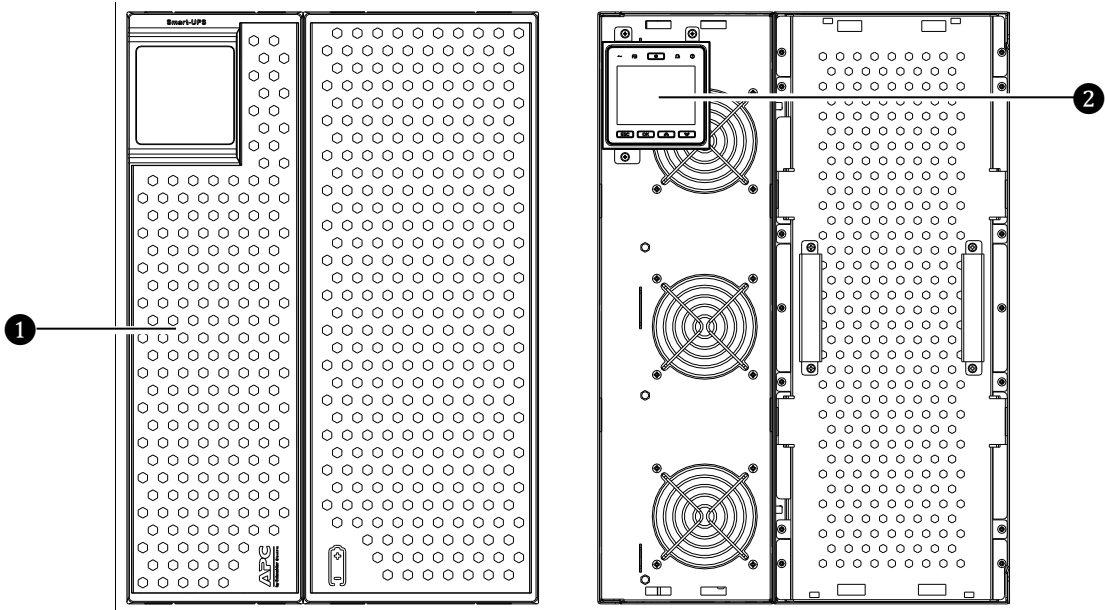
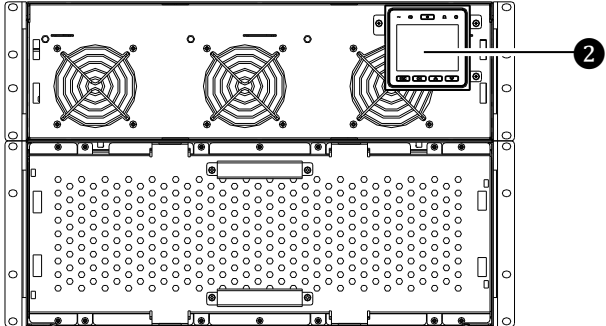
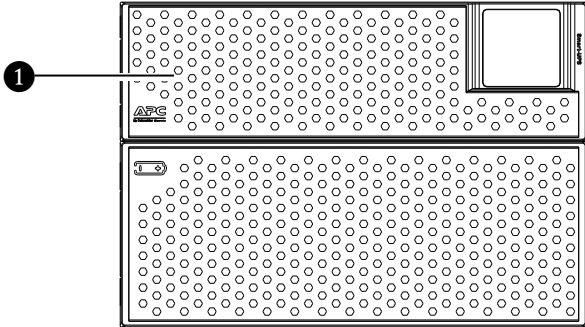



# Rear panel features

Note: Refer to the table “Key to identify rear panel features” that provides a key to the callout numbers for the rear panel graphics depicted in this manual.

This picture is for reference only. The physical object may be different.

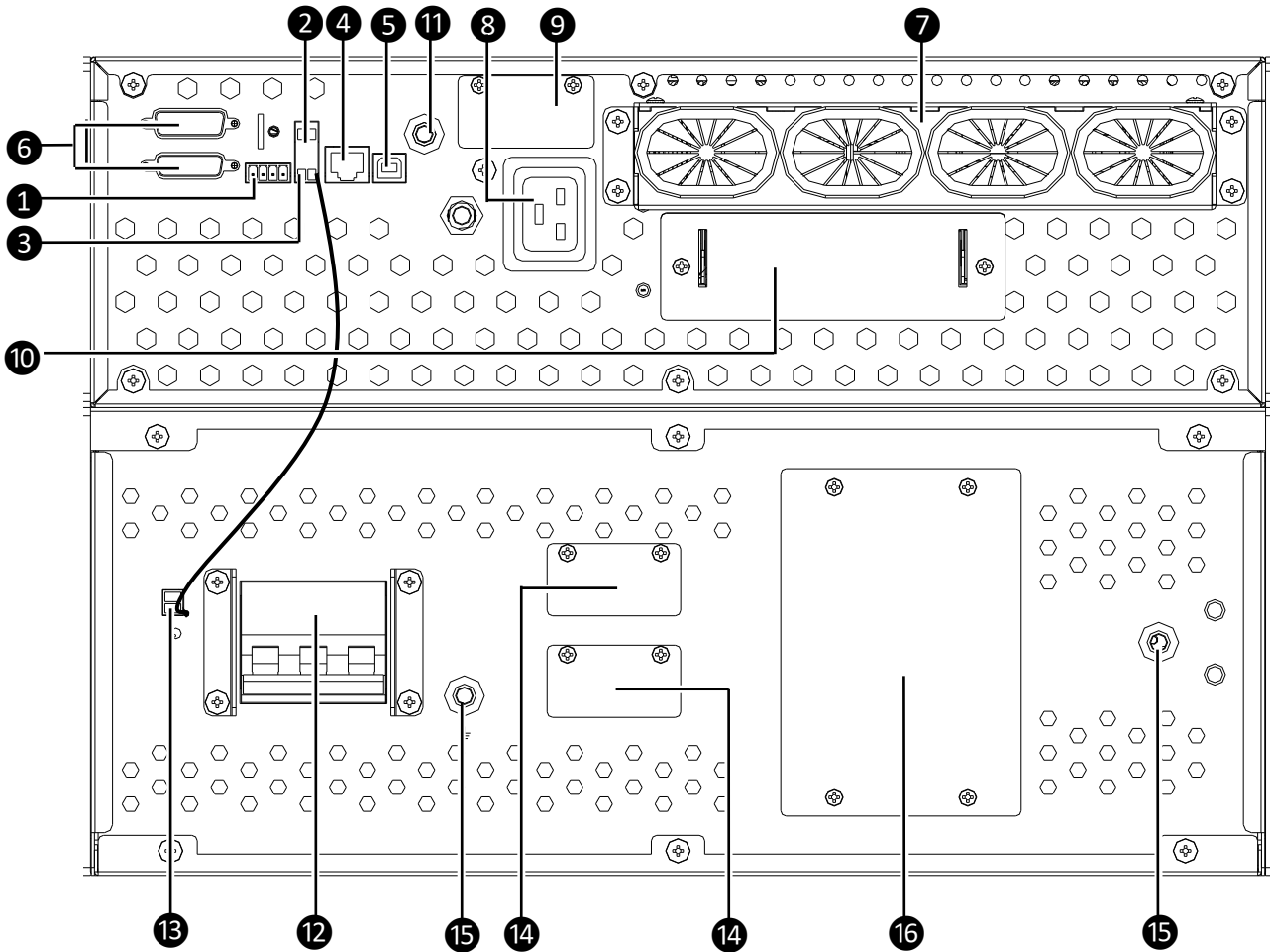

## Key to identify rear panel features

|   |                                     |   |
|---|-------------------------------------|---|
| ① | EPO terminal                        | The Emergency Power Off (EPO) terminal allows the user to connect the UPS to a central EPO system.  |
| ② | MBS terminal                        | Maintenance bypass signal. Connect MBS cable to UPS before maintenance switch turned on. Pull out the MBS terminal when necessary to maintain the UPS.  |
| ③ | BAT_T terminal                      | Battery temperature sensor.<br>Connect the battery pack temperature sensor cable between ③ and ⑬.   |
| ④ | RS232 port                          | The serial com port is used to communicate with the UPS. Use only interface kits supplied or approved by APC by Schneider Electric. Any other serial interface cable will be incompatible with the UPS connector.<br>Note: Remote firmware upgrade facility for this UPS model is not available, user needs to use RS232 port for firmware upgrade. |
| ⑤ | USB port                            | Communication interface only.   |
| ⑥ | Parallel Port                       | Parallel communication port.  |
| ⑦ | Input/Output hardware terminals     | Remove the cover to connect input and output wires to the hardware terminal blocks.   |
| ⑧ | Output socket with circuit breaker. | Connect electronic devices to these outlets.  |
| ⑨ | Battery Connector                   | External battery connector.   |
| ⑩ | Smart Slot                          | The Smart Slot can be used to connect optional management accessories.  |
| ⑪ | Ground Terminal                     | Connect to ground.  |
| ⑫ | Battery breaker                     | Connects or disconnects batteries.  |
| ⑬ | BAT_T                               | Battery temperature sensor.   |
| ⑭ | Battery connector                   | Enables connection of battery pack to UPS or connection of additional battery packs.  |
| ⑮ | Ground Terminal                     | Connect to ground.  |
| ⑯ | Battery Fuse                        | 2 nos. of 100 A / 500 VDC fuse.   |

# Wiring Specifications

## ⚠ CAUTION

### RISK OF ELECTRIC SHOCK

- Adhere to all national and local electrical codes.
- Wiring should be performed by a qualified electrician.
- The UPS must be connected to a branch circuit, equipped with a circuit breaker rated as specified in the tables below.





**Failure to follow these instructions can result in equipment damage and minor or moderate injury.**

## ⚠ CAUTION

### RISK OF FIRE

- In the case of “Dual input” operation, make sure the jumpers between the input lines have been removed.
- The AC input and the AC bypass supplies must be referenced to the same neutral point.

**Failure to follow these instructions can result in equipment damage and minor or moderate injury.**

| Input Connections  | Output Connections   |
|--|--|
| Main Input<br>Single-Phase: Wire to L1, Input-N, and <br>Three-Phase: Wire to L1, L2, L3, Input-N, and  | Hardwire<br>Single-Phase: Wire to L1, N, and <br>Three-Phase: Wire to L1, L2, L3, N, and  |
| Bypass Input (optional)<br>Single-Phase: Wire to B1, Bypass-N<br>Three-Phase: Wire to B1, B2, B3, Bypass-N   |  |

## Single Feed

|            | Wiring          | Number of Phases | Voltage                            | Current Full Load*** (maximum)         | External Input Circuit Breaker (typical) | Wire Size* (typical)                        |
|------------|-----------------|------------------|------------------------------------|--|--|---|
| SRTG15KXLI | Input           | 1                | 220/230/240 VAC                    | 100.2 A                                | 100 A                                    | 25 mm <sup>2</sup>                          |
|            | Output          | 1                | 220/230/240 VAC                    | 68.2 A                                 | not required                             | 16 mm <sup>2</sup>                          |
|            | Input<br>Output | 3<br>1           | 380/400/415 VAC<br>220/230/240 VAC | 33.5 A each phase<br>68.2 A            | 100 A**<br>not required                  | 25 mm <sup>2</sup> **<br>16 mm <sup>2</sup> |
| SRTG20KXLI | Input           | 3                | 380/400/415 VAC                    | 33.5 A each phase                      | 40 A each phase                          | 10 mm <sup>2</sup>                          |
|            | Output          | 3                | 380/400/415 VAC                    | 22.8 A each phase                      | not required                             | 6 mm <sup>2</sup>                           |
|            | Input<br>Output | 1<br>1           | 220/230/240 VAC<br>220/230/240 VAC | 124.1 A<br>90.9 A                      | 125 A<br>not required                    | 35 mm <sup>2</sup><br>25 mm <sup>2</sup>    |
| SRTG20KXLI | Input           | 3                | 380/400/415 VAC                    | 41.5 A each phase                      | 125 A**                                  | 35 mm <sup>2</sup> **                       |
|            | Output          | 1                | 220/230/240 VAC                    | 90.9 A                                 | not required                             | 25 mm <sup>2</sup>                          |
|            | Input<br>Output | 3<br>3           | 380/400/415 VAC<br>380/400/415 VAC | 41.5 A each phase<br>30.4 A each phase | 50 A each phase<br>not required          | 16 mm <sup>2</sup><br>10 mm <sup>2</sup>    |

## Dual Feed

|                    | Wiring          | Number of Phases | Voltage                            | Current Full Load*** (maximum)         | External Input Circuit Breaker Mains (typical) | External Input Circuit Breaker Bypass (typical) | Wire Size Mains* (typical)               | Wire Size Bypass* (typical)                 |
|--------------------|-----------------|------------------|------------------------------------|--|--|---|--|---|
| <b>SRTG15K XLI</b> | Input<br>Output | 1<br>1           | 220/230/240 VAC<br>220/230/240 VAC | 100.2 A<br>68.2 A                      | 100A<br>not required                           | 100A<br>not required                            | 25 mm <sup>2</sup><br>16 mm <sup>2</sup> | 25 mm <sup>2</sup><br>16 mm <sup>2</sup>    |
|                    | Input<br>Output | 3<br>1           | 380/400/415 VAC<br>220/230/240 VAC | 33.5 A each phase<br>68.2 A            | 40 A each phase<br>Not required                | 100 A **<br>not required                        | 10 mm <sup>2</sup><br>16 mm <sup>2</sup> | 25 mm <sup>2</sup> **<br>16 mm <sup>2</sup> |
|                    | Input<br>Output | 3<br>3           | 380/400/415 VAC<br>380/400/415 VAC | 33.5 A each phase<br>22.8 A each phase | 40 A each phase<br>Not required                | 40 A each phase<br>not required                 | 10 mm <sup>2</sup><br>6 mm <sup>2</sup>  | 10 mm <sup>2</sup><br>6 mm <sup>2</sup>     |
| <b>SRTG20K XLI</b> | Input<br>Output | 1<br>1           | 220/230/240 VAC<br>220/230/240 VAC | 124.1 A<br>90.9 A                      | 125 A<br>not required                          | 125 A<br>not required                           | 35 mm <sup>2</sup><br>25 mm <sup>2</sup> | 35 mm <sup>2</sup><br>25 mm <sup>2</sup>    |
|                    | Input<br>Output | 3<br>1           | 380/400/415 VAC<br>220/230/240 VAC | 41.5 A each phase<br>90.9 A            | 50 A each phase<br>Not required                | 125 A **<br>not required                        | 16 mm <sup>2</sup><br>25 mm <sup>2</sup> | 35 mm <sup>2</sup> **<br>25 mm <sup>2</sup> |
|                    | Input<br>Output | 3<br>3           | 380/400/415 VAC<br>380/400/415 VAC | 41.5 A each phase<br>30.4 A each phase | 50 A each phase<br>Not required                | 50 A each phase<br>not required                 | 16 mm <sup>2</sup><br>10 mm <sup>2</sup> | 16 mm <sup>2</sup><br>10 mm <sup>2</sup>    |

\*Terminal screw tightening torque: 4.5Nm (40 lb-in).

\*\*Use cables and input circuit breakers specified in above table.

Note: Units configured for three phase input and single phase output operation, the entire load connected to the UPS will transfer to L1 and Neutral of the three phase input when the UPS is operating in Bypass mode.

\*\*\*The current is specified at nominal input voltage.

# Connect Equipment

## CAUTION

### RISK OF ELECTRIC SHOCK

- Disconnect the mains input circuit breaker before installing or servicing the UPS or connected equipment.
- Disconnect internal and external batteries before installing or servicing the UPS.
- The UPS contains internal and external batteries that may present a shock hazard even when disconnected from the mains.
- The AC hardwired and pluggable outlets may be energized by remote or automatic control at any time.
- Disconnect equipment from the UPS before servicing.

**Failure to follow these instructions can result in equipment damage and minor or moderate injury.**

**Note:** The UPS batteries will charge to 90% capacity in the first 4 hours of normal operation.

**Do not expect full battery runtime during this initial charge period.**

1. Connect the UPS to the building utility power. Refer to the Installation manual supplied with the UPS.
2. Connect equipment to the outlets on the rear panel of the UPS.

# Turn the UPS On/Off

## WARNING

### RISK OF ELECTRIC SHOCK

The output sockets or terminals of the Smart-UPS can be energized when input voltage is applied to the unit.

**Failure to follow these instructions can result in death or serious injury and equipment damage.**

The first time the UPS is turned on the Setup Wizard screen will run. Follow the prompts to configure UPS settings. Refer to "Configuration" on page 17. After "Configuration" is completed, the UPS automatically enters "online" mode or "battery" mode.

**Note:**

1. When there is no input power and the UPS is off, the cold start feature can be used to turn on the UPS and connected equipment using battery power. To perform a cold start, press the POWER ON/OFF button for more than one second. The LCD will illuminate. To turn off output use **Turn Off Immediately** or **Turn Off with delay** command through LCD. To shutdown the UPS, use **Shutdown immediately** or **Shutdown with delay** command through LCD.
2. When the unit is working in mains standby mode and AC power is turned off, the UPS will continue to operate on battery standby mode for a while before shutting down.

# UPS Display Interface

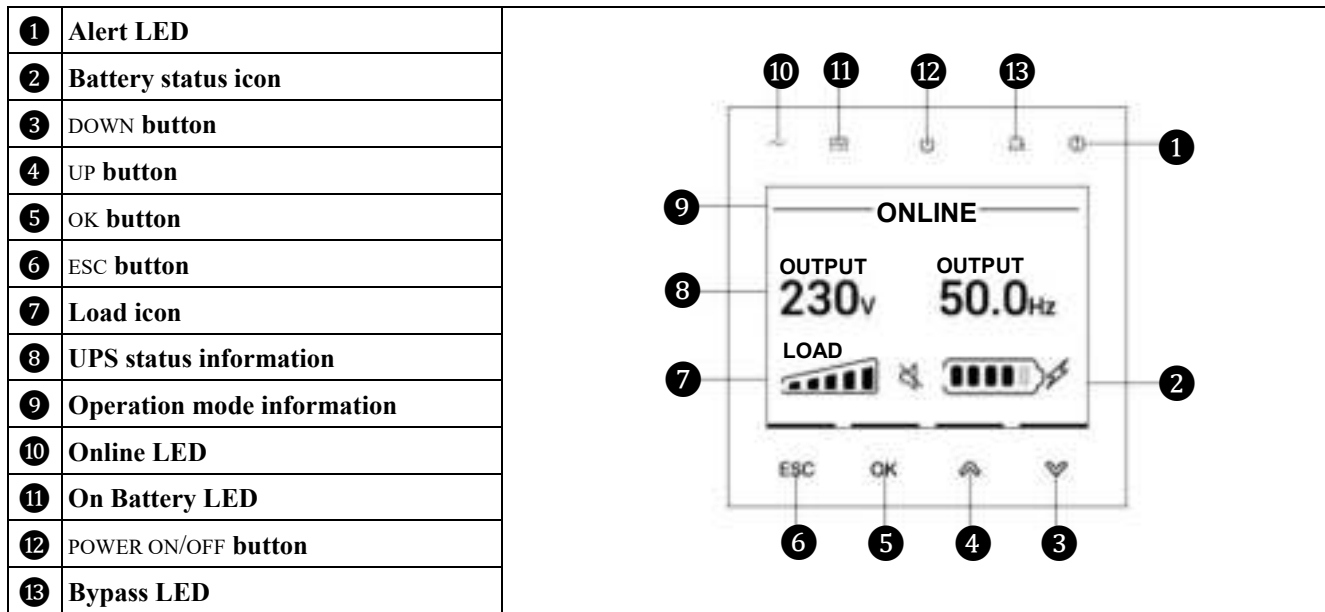

|  |   |
|--|---|
|  | <b>Load icon:</b> The approximate load capacity percentage is indicated by the number of load bar sections illuminated. Each bar represents 20% of the load capacity. |
|  | <b>Mute icon:</b> Indicates the audible alarm is disabled/mute.   |

## UPS status information

The status information field provides key information on the status of the UPS.



The **Main Screen** will scroll through the following parameters:

- Input Voltage
- Input Frequency
- Output Voltage
- Output Current
- Output Frequency
- Load Active Power
- Load Apparent Power
- Load Rate
- Battery Temperature
- Battery Capacity
- Battery Runtime
- Ambient Temp.

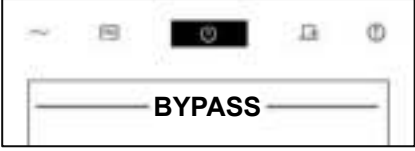

In the case of a UPS event, status updates will be displayed defining the event or condition that has occurred.

The display screen illuminates amber to indicate a precaution and red to indicate an Alert depending on the severity of the event or condition.

## Operation mode icons

|   |  |
|---|--|
|  | <p><b>On-Line mode:</b> The UPS is supplying conditioned mains power to connected equipment.</p>   |
|  | <p><b>Bypass mode:</b> The UPS is in <b>Bypass</b> mode and the connected equipment will receive mains power as long as the input voltage and frequency are within the configured limits. The UPS will not switch to Battery mode if mains power fails when the UPS is operating in Bypass mode.</p>   |
|  | <p><b>Green mode:</b> In <b>Green</b> mode mains power is sent directly to the load. In the event of a mains power outage, there will be an interruption in power to the load of up to 10ms while the UPS switches to <b>On-Line</b> or <b>Battery</b> mode. When enabling <b>Green</b> mode attention should be given to devices that may be sensitive to power fluctuations.</p> |
|  | <p><b>Battery mode:</b> The UPS is supplying battery power to connected equipment.</p>   |

## Battery status icons

|   |  |
|---|--|
|  | <p><b>Battery Capacity:</b> Indicates the battery power.</p>                 |
|  | <p><b>Battery Charge In Progress:</b> Indicates the battery is charging.</p> |

## UPS display interface operation

Use the UP/DOWN buttons to scroll through the options. Press the OK button to accept the selected option. Press the ESC button to return to the previous menu.

# Configuration Menus Overview

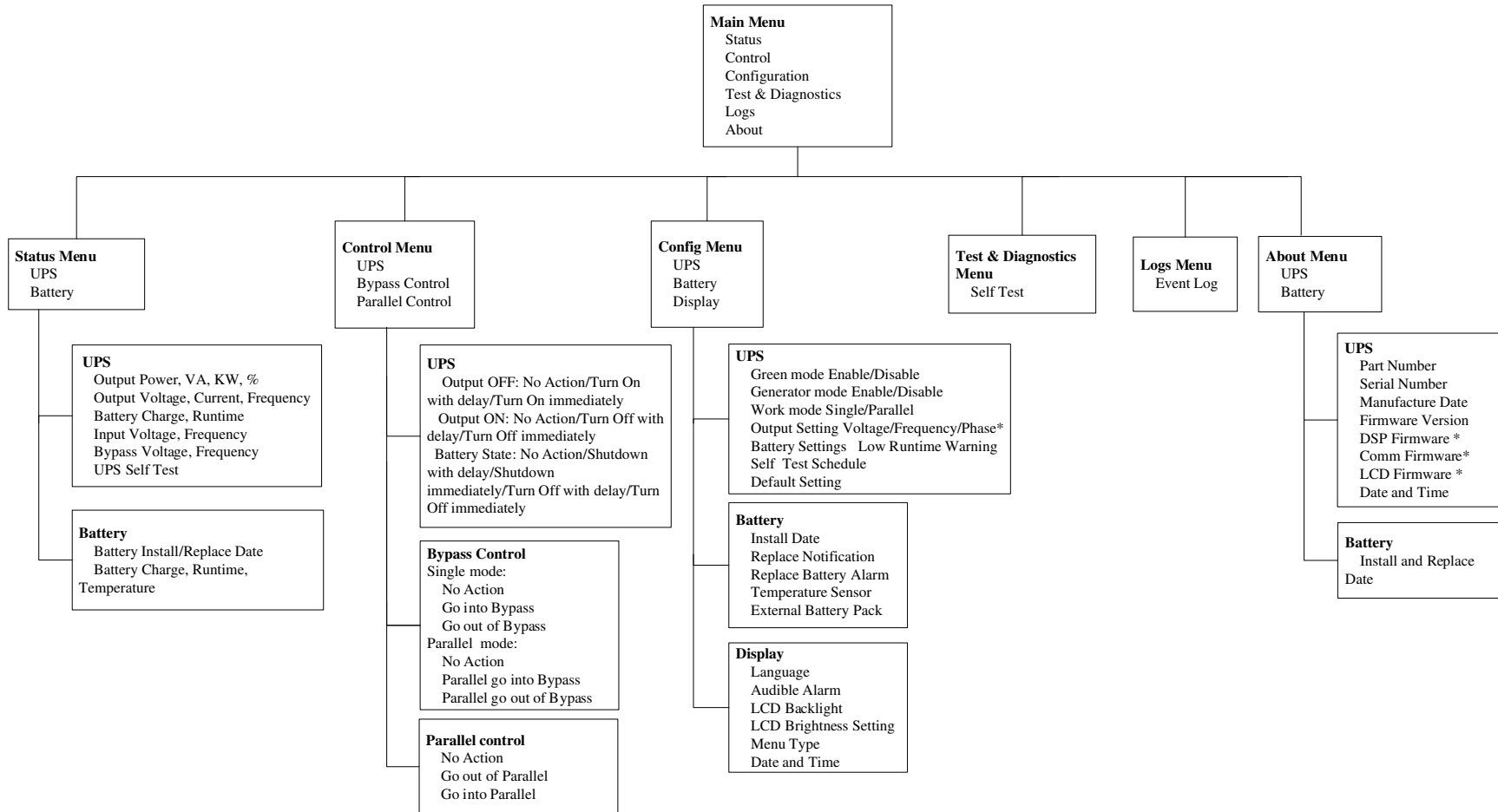

Menus are subject to change depending on the installed firmware version.

\* Available on the Advanced Menu Screens.

Note: To switch from Green mode to Bypass mode: disable Green mode and enable Go into Bypass using the LCD display interface.











# Configuration







## UPS settings

The first time the UPS is turned on the Setup wizard screen will open. On each menu screen select the desired settings. Press OK after each UPS setting is selected.

**Note:** The UPS will not turn on until all of the settings have been configured.

## Startup wizard

| Function   | Description  |
|--|--|
| <p><b>Language</b></p> <p>English </p> <p>Français</p> <p>Italiano</p> <p>Deutsch</p> <p>Español </p> <p><b>Language</b></p> <p>Deutsch </p> <p>Español</p> <p>Português</p> <p>Русский</p> <p>简体中文 </p> | <p>Select the language required for the UPS Display Interface.</p> <p>Options:</p> <ul style="list-style-type: none"> <li>• English</li> <li>• Français</li> <li>• Italiano</li> <li>• Deutsch</li> <li>• Espanol</li> <li>• Portugues</li> <li>• Русский</li> <li>• 简体中文</li> </ul> |
| <p><b>Input:Output Phase</b></p> <p>1:1 </p> <p>3:3</p> <p>3:1</p> <p></p>   | <p>Select the Input: Output Phase</p> <p>Options:</p> <ul style="list-style-type: none"> <li>• 1:1</li> <li>• 3:3</li> <li>• 3:1</li> </ul>  |
| <p><b>Voltage AC Setting</b></p> <p>220V </p> <p>230V </p> <p>240V</p> <p></p>  | <p>Select the output voltage (Input:Output phase is 1:1 or 3:1).</p> <p>Options:</p> <ul style="list-style-type: none"> <li>• 220 VAC</li> <li>• 230 VAC</li> <li>• 240 VAC</li> </ul>   |

|  |  |
|--|--|
| <p><b>Voltage AC Setting</b></p> <hr/> <p>380V </p> <p><b>400V</b></p> <p>415V</p> <hr/> <p></p> | <p>Select the output voltage (Input:Output phase is 3:3).<br/>Options:</p> <ul style="list-style-type: none"> <li>• 380 VAC</li> <li>• 400 VAC</li> <li>• 415 VAC</li> </ul>   |
| <p><b>Menu Type</b></p> <hr/> <p><b>Standard</b> </p> <p>Advanced</p> <hr/> <p></p>              | <p>Select the desired menu type.<br/>Options:</p> <ul style="list-style-type: none"> <li>• Standard</li> <li>• Advanced</li> </ul> <p>Refer to “Configuration Menu Overview” on page 16 for details on parameters which need to be configured using Advanced Menu.</p> |
| <p><b>Battery Setting</b></p> <hr/> <p>External Battery Pack<br/>Number:</p> <p> 1 </p>        | <p>Set the number of external battery packs.<br/>Minimum battery pack: 0<br/>Maximum battery pack: 4</p>   |
| <p><b>Battery Setting</b></p> <hr/> <p>Install Date:<br/>All RBC<br/><b>12</b> - Jun - 2019</p>  | <p>Set the installation date of all RBC.</p>   |
| <p><b>Date and Time:</b></p> <hr/> <p><b>2019</b> - 01 - 01<br/>00:00: 00</p>  | <p>Set the Date and Time.</p>  |

## General settings

Configure these settings at any time, using the UPS Display Interface, or the Network Management web Interface.

|                    | Parameters                      | Default Value                             | Options   | Description   |
|--------------------|---------------------------------|---|---|---|
| Config<br>Menu UPS | <b>Green Mode</b>               | Disable                                   | Disable<br>Enable   | Disable or enable Green mode operation. If the Green mode is turned on, the generator mode cannot be set.   |
|                    | <b>Generator Mode</b>           | Disable                                   | Disable<br>Enable   | Disable or enable Generator mode operation. If <b>Generator mode</b> is enabled, the <b>Green mode</b> cannot be set. To enable <b>Green mode</b> , disable <b>Generator mode</b> first. Output power de-rates to 75% in 1:1 mode, if unit is operating in frequency converter mode. No derating for 3:1 and 3:3 modes. |
|                    | <b>Operating Mode</b>           | Single Mode                               | Single Mode<br>Parallel Mode  | Set the operating mode for UPS.   |
|                    | <b>Parallel ID</b>              | 1   | 1-4   | Set the parallel ID for UPS.  |
|                    | <b>Parallel Units</b>           | 2   | 2-4   | Set the parallel units of UPS.  |
|                    | <b>Parallel Redundant Units</b> | 0   | 0-3   | Set the redundant units of UPS.   |
|                    | <b>Output Voltage</b>           | 1:1 or 3:1 mode: 230 V<br>3:3 mode: 400 V | 1:1 or 3:1 mode:<br>230 V, 220 V, 240 V<br>3:3 mode:<br>380 V, 400 V, 415 V | Set the output voltage for the UPS. This setting can only be changed when the UPS output is off. These settings may vary depending on the UPS model.  |
|                    | <b>Output Phase</b>             | 1:1                                       | 1:1<br>3:1<br>3:3   | Set the input and output phase. This setting can be set in advanced mode and when the UPS output is off.  |
|                    | <b>Output Frequency</b>         | Auto                                      | Auto<br>50 Hz<br>60 Hz  | Set the output frequency for the UPS. This setting can be changed only when the UPS output is turned off.   |
|                    | <b>Low Runtime Alarm</b>        | 150 seconds                               | 0 to 1800 seconds   | The UPS will emit an audible alarm when the remaining runtime has reached this threshold.   |
|                    | <b>Self Test Schedule</b>       | Startup + every 14 days since last test   | Never<br>Startup<br>Startup + 14 days<br>Startup + 7 days                   | This is the interval at which the UPS will execute a <b>Self Test</b> .   |
|                    | <b>Default Setting</b>          | No  | Yes/No  | Allows the user to restore the UPS factory default settings. This setting can be changed only when the UPS output is turned off.  |

|                        | Parameters                     | Default Value       | Options                           | Description  |
|------------------------|--------------------------------|---------------------|-----------------------------------|--|
| Config Menu Battery    | Install Date                   | 01-Dec-2019         | Day-Month-Year                    | Enter the installation date of the RBCs.   |
|                        | Replacement Notification Time  | 180 days            | 0-730 days                        | To set the <b>Near End of Life</b> audible alarm, select the number of days before the estimated battery end of life. When this date is reached the UPS will emit an audible alarm and a message will appear on the UPS Display Interface screen. Example: Using the default value, the <b>Near End of Life</b> audible alarm will occur 180 days before the estimated end of life date. |
|                        | Replacement Battery Alarm Time | 14 days             | 0-365 days                        | The <b>Near End of Life</b> audible alarm can be muted. Enter the number of days between the time a <b>Near End of Life</b> audible alarm is acknowledged and the next <b>Near End of Life</b> audible alarm occurs.   |
|                        | Temperature Sensor             | Enable              | Disable/Enable                    | Select whether to enable or disable the battery temperature sensor.  |
|                        | External Battery Pack          | 0                   | 0-4                               | Set the number of external batteries   |
|                        | Config Menu Display            | Language            | English                           | English<br>Francais<br>Italiano<br>Deutsch<br>Espanol<br>Portugues<br>Русский<br>简体中文  |
| Audible Alarm          |                                | Medium              | Disable<br>Soft<br>Medium<br>Loud | When audible alarms are disabled, the UPS will not emit an audible alarm.  |
| LCD Backlight          |                                | Auto Dim            | Auto Dim<br>Auto Off<br>Always On | To conserve energy, the LCD back light illumination dims or turns off when no events are active. Full UPS Display Interface illumination returns when the UPS changes status as a result of an event or when any button on the UPS Display Interface is pressed.   |
| LCD Brightness Setting |                                | 3                   | 1-5                               | Adjust the brightness and contrast individually for each LCD back light color.   |
| Menu Type              |                                | Standard            | Standard<br>Advanced              | The <b>Standard</b> menus include the most commonly used options. The <b>Advanced</b> menu options include all parameters.   |
| Date and Time          |                                | 2019-01-01 00:00:00 | Date and time                     | Enter the current date and time.   |

# Emergency Power Off

## Overview

The Emergency Power Off (EPO) option is a feature that will immediately disconnect all connected equipment from UPS power. The UPS will turn off the output when the EPO function is triggered.

To restore the unit – when the UPS is working in Online mode:

1. Turn off the AC power and wait for the UPS to shut down.
2. Turn on the AC power to UPS to reset the EPO function.
3. To turn on the output use the **Turn On Immediately** or **Turn On with delay** command through LCD.

To restore the unit – when the UPS is working in Battery mode:

1. UPS will shut down after the EPO function is triggered.
2. Press the POWER ON/OFF button to turn on the UPS.

### ⚠ CAUTION

#### RISK OF ELECTRIC SHOCK

- Adhere to all national and local electrical codes.
- Wiring must be performed by a qualified electrician.
- Always connect the UPS to a grounded outlet.

**Failure to follow these instructions can result in equipment damage and minor or moderate injury.**

## Normally closed & open contacts

Use 16-28AWG wire, secure the wires by tightening the screws.

| EPO              | EPO Wiring Diagram | Function   |
|------------------|--------------------|--|
| EPO-NC (Default) |                    | <ol style="list-style-type: none"> <li>1. Remove the wire jumper between terminals 3 &amp; 4.</li> <li>2. Connect wires from the Normally Closed (NC) contact of the EPO switch/relay.</li> </ol> <p>The EPO function will be triggered when the wire jumper between pins 3 and 4 is removed or the EPO contact changes to Normally Open (NO).</p> |
| EPO-NO           |                    | <ol style="list-style-type: none"> <li>1. Connect wires from the Normally Open (NO) contact of the EPO switch/relay.</li> </ol> <p>The EPO function will be triggered when wire jumper between terminals 3 and 4 is removed or the EPO switch/relay contact changes to NC.</p>   |

The EPO interface is a Safety Extra Low Voltage (SELV) circuit.

The EPO switch or relay should be rated for “dry” circuit applications, the rating should be for low voltage and low current applications.

# Overview of Parallel System

**Note:** In parallel systems with an external maintenance bypass breaker Ext. MBB, the maintenance bypass breakers MBB must be padlocked in the open position.

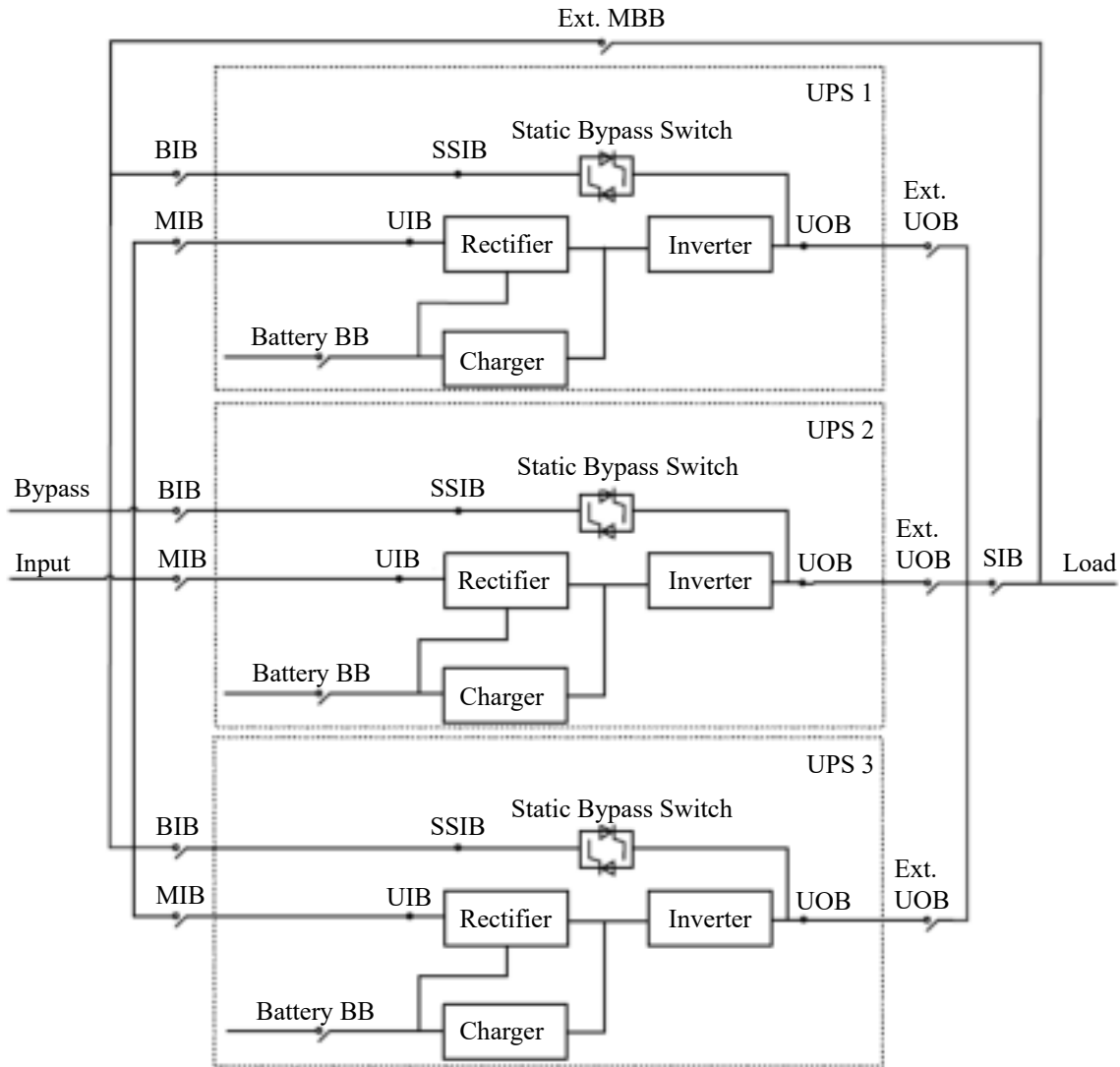

|          |                                     |
|----------|-------------------------------------|
| MIB      | Mains input breaker                 |
| BIB      | Bypass input breaker                |
| UIB      | Unit input breaker                  |
| SSIB     | Static switch input breaker         |
| UOB      | Unit output breaker                 |
| Ext. UOB | External unit output breaker        |
| Ext. MBB | External maintenance bypass breaker |
| SIB      | System isolation breaker            |
| BB       | Battery breaker                     |

## Wiring specification:

|             | Number of Phases | Wiring | Voltage               | Mains circuit               |                     | SRTG15KXLI                  |                     | SRTG20KXLI                  |                     | MBS Wire Size (typical) |                    |
|-------------|------------------|--------|-----------------------|-----------------------------|---------------------|-----------------------------|---------------------|-----------------------------|---------------------|-------------------------|--------------------|
|             |                  |        |                       | Current Full Load (maximum) | Wire Size (typical) | Current Full Load (maximum) | Wire Size (typical) | Current Full Load (maximum) | Wire Size (typical) |                         |                    |
| Single Feed | 1:1              | Input  | 220/230/240 VAC       | 248.2 A                     | 120 mm <sup>2</sup> | 100.2 A                     | 25 mm <sup>2</sup>  | 124.1 A                     | 35 mm <sup>2</sup>  | 0.3 mm <sup>2</sup>     |                    |
|             |                  | Output | 220/230/240 VAC       | 181.8 A                     | 70 mm <sup>2</sup>  | 68.2 A                      | 16 mm <sup>2</sup>  | 90.9 A                      | 25 mm <sup>2</sup>  |                         |                    |
|             | 3:1              | Input  | L1 and N<br>L2 and L3 | 380/400/415 VAC             | 248.2 A             | 120 mm <sup>2</sup>         | 100.2 A             | 25 mm <sup>2</sup>          | 124.1 A             |                         | 35 mm <sup>2</sup> |
|             |                  |        |                       |                             | 83 A each phase     | 25 mm <sup>2</sup>          | 33.5 A each phase   | 25 mm <sup>2</sup>          | 41.5 A each phase   |                         | 35 mm <sup>2</sup> |
|             |                  | Output | 220/230/240 VAC       | 181.8 A                     | 70 mm <sup>2</sup>  | 68.2 A                      | 16 mm <sup>2</sup>  | 90.9 A                      | 25 mm <sup>2</sup>  |                         |                    |
|             | 3:3              | Input  | 380/400/415 VAC       | 83 A each phase             | 25 mm <sup>2</sup>  | 33.5 A each phase           | 10 mm <sup>2</sup>  | 41.5 A each phase           | 16 mm <sup>2</sup>  |                         |                    |
|             |                  | Output | 380/400/415 VAC       | 60.8 A each phase           | 25 mm <sup>2</sup>  | 22.8 A each phase           | 6 mm <sup>2</sup>   | 30.4 A each phase           | 10 mm <sup>2</sup>  |                         |                    |
| Dual Feed   | 1:1              | Input  | 220/230/240 VAC       | 248.2 A                     | 120 mm <sup>2</sup> | 100.2 A                     | 25 mm <sup>2</sup>  | 124.1 A                     | 35 mm <sup>2</sup>  |                         |                    |
|             |                  | Output | 220/230/240 VAC       | 181.8 A                     | 70 mm <sup>2</sup>  | 68.2 A                      | 16 mm <sup>2</sup>  | 90.9 A                      | 25 mm <sup>2</sup>  |                         |                    |
|             | 3:1              | Input  | Mains                 | 380/400/415 VAC             | 83 A each phase     | 25 mm <sup>2</sup>          | 33.5 A each phase   | 10 mm <sup>2</sup>          | 41.5 A each phase   |                         | 16 mm <sup>2</sup> |
|             |                  |        | BPS*                  |                             | 248.2 A             | 120 mm <sup>2</sup>         | 100.2 A             | 25 mm <sup>2</sup>          | 124.1 A             |                         | 35 mm <sup>2</sup> |
|             |                  | Output | 220/230/240 VAC       | 181.8 A                     | 70 mm <sup>2</sup>  | 68.2 A                      | 16 mm <sup>2</sup>  | 90.9 A                      | 25 mm <sup>2</sup>  |                         |                    |
|             | 3:3              | Input  | 380/400/415 VAC       | 83 A each phase             | 25 mm <sup>2</sup>  | 33.5 A each phase           | 10 mm <sup>2</sup>  | 41.5 A each phase           | 16 mm <sup>2</sup>  |                         |                    |
|             |                  | Output | 380/400/415 VAC       | 60.8 A each phase           | 25 mm <sup>2</sup>  | 22.8 A each phase           | 6 mm <sup>2</sup>   | 30.4 A each phase           | 10 mm <sup>2</sup>  |                         |                    |

\*BPS: Bypass

# Network Management Interface

## Introduction

The UPS has a network port and a console port that can be used to access the Network Management Interface. To access all the network management documentation and to download firmware updates, configuration wizards and MIB, visit <https://www.apc.com/upsnmc>.

For network-based, graceful, unattended shutdown of your physical servers and virtual machines, it is highly recommended that you install the latest version of **PowerChute™ Network Shutdown**. Learn more and download for free from <https://www.apc.com/pcns>.

## IP Address Configuration

The default TCP/IP configuration setting DHCP, assumes that a properly configured DHCP server is available to provide TCP/IP settings to the Network Management Interface.

If the Network Management Interface obtains an IPv4 address from a DHCP server, use the display interface menus About/Accessory, to see the address.

To setup a static IPv4 address use the display interface Config menu. Set the IP address Subnet Mask and Gateway from the Config menu.

See the NMC installation manual for user information about the Network Management Interface and for setup instructions.

## Related Documents

The following documentation is available on the APC by Schneider Electric Web site:

- UPS Network Management Card User Guide
- UPS Network Management Card Command Line Interface Guide
- UPS Network Management Card Modbus Documentation Addendum
- UPS Network Management Card Modbus Register Maps
- Network Management Card Upgrade Utilities
- Security Handbook
- PowerNet ® Management Information Base (MIB) Reference Guide
- Declaration of Conformity



# Replace the RBCs

**An RBC should only be disconnected or removed from the UPS temporarily as part of the battery replacement procedure.**

- Disconnect all connected battery modules in the UPS. Slide the RBCs out of the UPS.
- Slide the new RBCs into the UPS and connect the battery modules to the UPS.
- Securely connect each battery module. Press the battery connector into the UPS until it is firmly connected.
- A battery that is not fully connected will cause erratic UPS operation, abnormal alert messages and connected equipment may not receive battery power during power outages.
- After installing the RBC, the UPS display interface may prompt the user to verify the status of the replaced battery modules. If the battery module is new, respond YES. If the battery module is not new, respond NO.

# Troubleshooting

Use the table below to solve minor installation and operation problems.

Refer to the APC by Schneider Electric Web site, [www.apc.com](http://www.apc.com) for assistance with complex UPS problems and Firmware upgrade or contact your local Customer Care Center for more information.

**Note:** Before starting up, make sure the mains input, bypass input and output connections are correct.

| Detected error and Possible Cause   | Solution  |
|---|---|
| <b>UPS will not turn on or there is no output</b>   |   |
| The UPS is not connected to mains power.  | Be sure the power cable is securely connected to the UPS and to the mains power supply.   |
| The UPS display interface screen shows very low or no mains power.                                    | Check the mains power supply to verify acceptable power quality.  |
| There is an internal UPS alert.   | The UPS Display Interface screen will show a message to identify the alert and corrective action.   |
| <b>UPS emits an audible alarm</b>   |   |
| Normal UPS operation when running on battery power.   | <ul style="list-style-type: none"> <li>The UPS is operating on battery power.</li> <li>Press ESC key to mute the audible alarm.</li> </ul>  |
| The UPS emits an audible alarm and has a red or amber back light on the LCD Display Interface screen. | <ul style="list-style-type: none"> <li>An <b>Alarm</b> or <b>Notification</b> condition exists. Follow the instructions on the LCD Display Interface screen.</li> <li>Press ESC key to mute the audible alarm.</li> </ul>   |
| The LCD display interface screen displays an overload condition.                                      | <ul style="list-style-type: none"> <li>The connected equipment exceeds the specified maximum load. Refer to the APC by Schneider Electric Web site, <a href="http://www.apc.com">www.apc.com</a> for product specifications.</li> <li>The UPS will emit a sustained audible alarm till the overload condition exists.</li> <li>Disconnect nonessential equipment from the UPS to correct the overload condition.</li> </ul> |
| <b>UPS does not provide expected backup time</b>  |   |
| The UPS batteries are weak due to a recent power outage.  | <ul style="list-style-type: none"> <li>Charge the batteries.</li> <li>Batteries require recharging after extended outages and wear out faster when put into service often or when operated at elevated temperatures.</li> </ul>   |
| The UPS batteries are near the end of service life.   | If the batteries are near the end of service life, consider replacing the batteries even if the <b>Replace Battery</b> message is not displayed.  |
| <b>UPS operates on battery power while connected to mains power</b>                                   |   |
| The input circuit breaker has tripped.  | <ul style="list-style-type: none"> <li>Reduce the load on the UPS.</li> <li>Disconnect nonessential equipment and switch on the circuit breaker.</li> <li>Check the circuit breaker rating for the connected equipment.</li> </ul>  |
| There is very high, very low, or distorted input line voltage.  | <ul style="list-style-type: none"> <li>Navigate to the LCD Display Interface screen that shows input voltage. Verify that the input voltage is within specified operating limits.</li> <li>If no input voltage is indicated on the LCD Display Interface screen, contact Customer Support through the APC by Schneider Electric Web site, <a href="http://www.apc.com">www.apc.com</a>.</li> </ul>                          |
| <b>UPS Display Interface Status screen shows UPS is operating in Bypass mode</b>                      |   |
| The UPS received a command to operate in Bypass mode.   | No action is required.  |

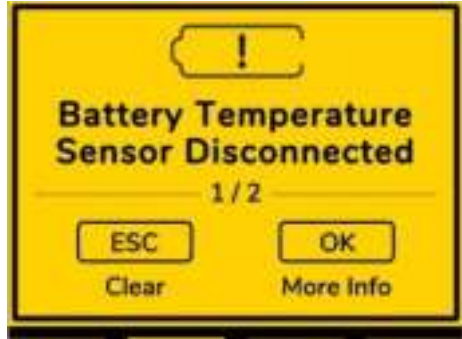
| Detected error and Possible Cause  | Solution  |
|--|---|
| The UPS has automatically switched to <b>Bypass</b> mode due to an internal UPS alert.   | <ul style="list-style-type: none"> <li>The LCD Display Interface screen will show a message to identify the alert and the corrective action to be taken.</li> </ul>   |
| <b>The LCD Display Interface screen displays Battery Disconnected</b>  |   |
| UPS does not detect the battery  | <ul style="list-style-type: none"> <li>Be sure the battery cables are securely connected.</li> <li>Perform a UPS <b>Self Test</b> using the LCD Display Interface -&gt; menu option -&gt; <b>Test and Diagnostics</b> to be sure that the UPS detects all the connected batteries.</li> </ul> |
| <b>The UPS display turns red or amber, displays an alert message, and emits a sustained audible alarm. Red illumination indicates a UPS alarm that requires immediate attention<br/>Amber illumination indicates a UPS alarm that requires attention</b> |   |
| <p>There is an UPS internal alert.</p>    | Do not attempt to use the UPS. Turn the UPS off and have it serviced immediately.   |
| <p>The UPS is experiencing an abnormal condition.</p>   | Check the UPS according to displayed information.   |
| The set date for Battery Replacement has been reached.   | Replace the battery at the set date.  |
| Installation date is not set after battery replacement.  | Set the correct date of installation of battery.  |

If the XLBP does not work normally, it might be due to improper installation, wiring or operation.

Be sure that the XLBP has been installed and wired properly. Follow the instructions in the manuals supplied with the XLBP for operating the XLBP.

If the XLBP still does not work normally, then contact Customer Support through APC by Schneider Electric Web site, [www.apc.com](http://www.apc.com) or contact your local Customer Care Center for more information.

Provide the following information when asked:

1. Product model name and serial number.
2. Try to describe the detected problem with additional details such as LCD display info, LED lights status, etc.

Use the table below to solve minor installation and operation issues.

| <b>Detected error and Possible Cause</b>                          | <b>Solution</b>   |
|---|---|
| <b>Battery LED is flashing but no voltage at terminals</b>        |   |
| Battery breaker is not switched on.                               | Switch on the battery breaker.  |
| Batteries are EOL, low voltage etc.                               | Replace whole group of batteries.   |
| Battery number and capacity is not set correctly in UPS settings. | Set the correct number of batteries and the capacity connected to the UPS using the LCD display.  |
| <b>UPS does not cold start</b>                                    |   |
| Battery breaker is not switched on.                               | Be sure that the battery breaker is switched on.  |
| Battery fuse is open.   | Change the battery fuse.  |
| Battery charge is low.  | Charge the batteries.   |
| <b>Battery EOD* audible alarm</b>                                 |   |
| Battery is fully discharged.                                      | Charge the batteries.   |
| <b>Low battery voltage audible alarm</b>                          |   |
| Battery voltage is low.   | Charge the batteries.   |
| <b>Battery disconnected audible alarm</b>                         |   |
| The battery is not connected to the UPS.                          | <ul style="list-style-type: none"> <li>• Be sure that the battery connector is securely connected to the UPS.</li> <li>• Be sure that all RBCs are securely connected.</li> </ul> |
| <b>Battery charger error detected</b>                             |   |
| The UPS has detected an internal error in the charger.            | <ul style="list-style-type: none"> <li>• Switch off the UPS, disconnect the UPS from AC Mains.</li> <li>• Contact your dealer or local Customer Care Center.</li> </ul>           |

\* EOD: End of Discharge

# Transport

1. Shut down the UPS and disconnect all connected equipment.
2. Disconnect the unit from mains power.
3. Disconnect all internal and external batteries (if applicable).
4. Follow the shipping instructions outlined in the Service section of this manual.

# Service

If the unit requires service, do not return it to the dealer. Follow these steps:

1. Review the Troubleshooting section of the manual to eliminate common problems.
2. If the problem persists, contact APC by Schneider Electric Customer Support through the APC by Schneider Electric Web site. **www.apc.com**.
  - a. Note the model number and serial number and the date of purchase. The model and serial numbers are located on the rear panel of the unit and are available through the LCD display on select models.
  - b. Call APC by Schneider Electric Support and a technician will attempt to solve the problem over the phone. If this is not possible, the technician will issue a Returned Material Authorization Number (RMA#).
  - c. If the unit is under warranty, the repairs are free.
  - d. Service procedures and returns may vary internationally. Refer to the APC by Schneider Electric Web site for country specific instructions.
3. Pack the unit properly to avoid damage in transit. Never use foam beads for packaging. Damage sustained in transit is not covered under warranty.
4. **Before shipping, always disconnect all battery modules in a UPS or external battery pack.**
5. Write the RMA# provided by Customer Support on the outside of the package.
6. Return the unit by insured, prepaid carrier to the address provided by Customer Support.

# Limited Factory Warranty

Schneider Electric IT Corporation (SEIT), warrants its products to be free from defects in materials and workmanship for a period of three (3) years excluding the batteries, which are warranted for two (2) years from the date of purchase. The SEIT obligation under this warranty is limited to repairing or replacing, at its own sole option, any such defective products. Repair or replacement of a defective product or part thereof does not extend the original warranty period. This warranty applies only to the original purchaser who must have properly registered the product within 10 days of purchase. Products may be registered online at [warranty.apc.com](http://warranty.apc.com).

SEIT shall not be liable under the warranty if its testing and examination disclose that the alleged defect in the product does not exist or was caused by end user or any third person misuse, negligence, improper installation, testing, operation or use of the product contrary to SEIT recommend actions of specifications. Further, SEIT shall not be liable for defects resulting from: 1) unauthorized attempts to repair or modify the product, 2) incorrect or inadequate electrical voltage or connection, 3) inappropriate on site operation conditions, 4) Acts of God, 5) exposure to the elements, or 6) theft. In no event shall SEIT have any liability under this warranty for any product where the serial number has been altered, defaced, or removed.

**EXCEPT AS SET FORTH ABOVE, THERE ARE NO WARRANTIES, EXPRESS OR IMPLIED, BY OPERATION OF LAW OR OTHERWISE, APPLICABLE TO PRODUCTS SOLD, SERVICED OR FURNISHED UNDER THIS AGREEMENT OR IN CONNECTION HERewith.**

**SEIT DISCLAIMS ALL IMPLIED WARRANTIES OF MERCHANTABILITY, SATISFACTION AND FITNESS FOR A PARTICULAR PURPOSE.**

**SEIT EXPRESS WARRANTIES WILL NOT BE ENLARGED, DIMINISHED, OR AFFECTED BY AND NO OBLIGATION OR LIABILITY WILL ARISE OUT OF, SEIT RENDERING OF TECHNICAL OR OTHER ADVICE OR SERVICE IN CONNECTION WITH THE PRODUCTS.**

**THE FOREGOING WARRANTIES AND REMEDIES ARE EXCLUSIVE AND IN LIEU OF ALL OTHER WARRANTIES AND REMEDIES. THE WARRANTIES SET FORTH ABOVE CONSTITUTE SEIT'S SOLE LIABILITY AND PURCHASER EXCLUSIVE REMEDY FOR ANY BREACH OF SUCH WARRANTIES.**

**SEIT WARRANTIES EXTEND ONLY TO ORIGINAL PURCHASER AND ARE NOT EXTENDED TO ANY THIRD PARTIES.**

**IN NO EVENT SHALL SEIT, ITS OFFICERS, DIRECTORS, AFFILIATES OR EMPLOYEES BE LIABLE FOR ANY FORM OF INDIRECT, SPECIAL, CONSEQUENTIAL OR PUNITIVE DAMAGES, ARISING OUT OF THE USE, SERVICE OR INSTALLATION OF THE PRODUCTS, WHETHER SUCH DAMAGES ARISE IN CONTRACT OR TORT, IRRESPECTIVE OF FAULT, NEGLIGENCE OR STRICT LIABILITY OR WHETHER SEIT HAS BEEN ADVISED IN ADVANCE OF THE POSSIBILITY OF SUCH DAMAGES. SPECIFICALLY, SEIT IS NOT LIABLE FOR ANY COSTS, SUCH AS LOST PROFITS OR REVENUE, WHETHER DIRECT OR INDIRECT, LOSS OF EQUIPMENT, LOSS OF USE OF EQUIPMENT, LOSS OF SOFTWARE, LOSS OF DATA, COSTS OF SUBSTITUTANTS, CLAIMS BY THIRD PARTIES, OR OTHERWISE.**

**NOTHING IN THIS LIMITED WARRANTY SHALL SEEK TO EXCLUDE OR LIMIT OR DEATH OR PERSONAL INJURY RESULTING FROM ITS NEGLIGENCE OR ITS FRAUDULENT MISREPRESENTATION OF TO THE EXTENT THAT IT CANNOT BE EXCLUDED OR LIMITED BY APPLICABLE LAW.**

To obtain service under warranty you must obtain a Returned Material Authorization (RMA) number from customer support. Customers with warranty claims issues may access the SEIT worldwide customer support network through the APC by Schneider Electric Web site: [www.apc.com](http://www.apc.com). Select your country from the country selection drop down menu. Open the Support tab at the top of the web page to obtain information for customer support in your region. Products must be returned with transportation charges prepaid and must be accompanied by a brief description of the problem encountered and proof of date and place of purchase.



# APC by Schneider Electric

## Worldwide Customer Support

Customer support for this or any other APC™ by Schneider Electric product is available at no charge in any of the following ways:

- Visit the APC by Schneider Electric Web site to access documents in the APC by Schneider Electric Knowledge Base and to submit customer support requests.
  - **www.apc.com** (Corporate Headquarters)  
Connect to localized APC by Schneider Electric Web sites for specific countries, each of which provides customer support information.
  - **www.apc.com/support/**  
Global support searching APC by Schneider Electric Knowledge Base and using e-support.
- Contact APC by Schneider Electric Customer Support Center by telephone or e-mail.
  - Local, country specific centers: go to **www.apc.com/support/contact** for contact information.

For information on how to obtain local customer support, contact the APC by Schneider Electric representative or other distributor from whom you purchased your APC by Schneider Electric product.

Customer support and warranty information are available on the APC by Schneider Electric Web site, **www.apc.com**.

© 2020 APC by Schneider Electric. APC, the APC logo, PowerChute, and Smart-UPS are owned by Schneider Electric Industries S.A.S. or their affiliated companies. All other trademarks are property of their respective owners.

**EN 990-6201**

**12/2020**